

OWNER'S MANUAL

READ AND UNDERSTAND THIS ENTIRE MANUAL BEFORE USING!

6V MINI QUAD 6109/2628/2433 - ZP5251

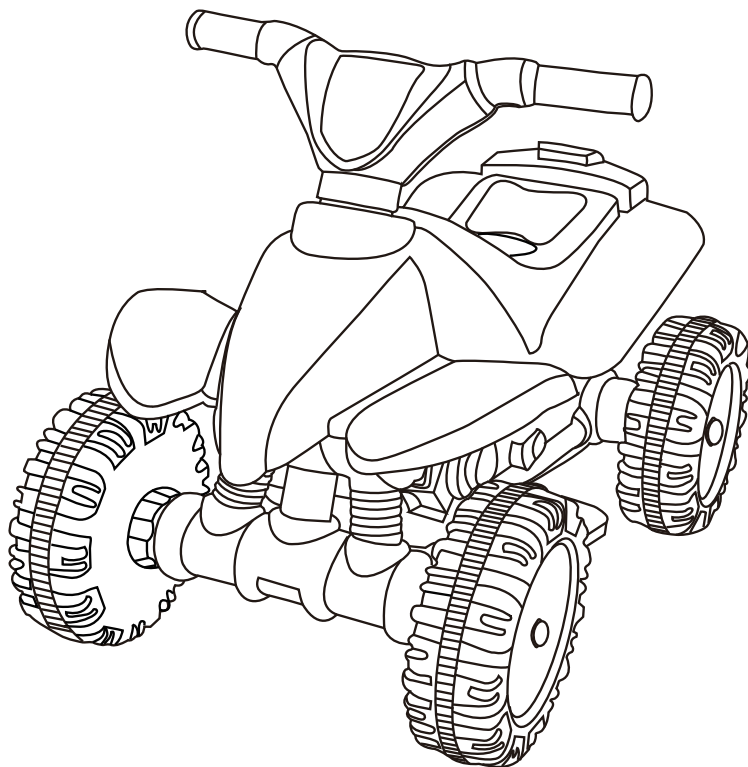

SUITABLE FOR 18-36M
MAXIMUM USER WEIGHT: 20KG
ADULT ASSEMBLY AND
SUPERVISION REQUIRED

BOX CONTENTS:
TOY MINI QUAD WITH BATTERY
CHARGER
SPANNER
OWNER'S MANUAL

BEFORE FIRST TIME USE, CHARGE THE BATTERY FOR AT LEAST 8-12 HOURS.
PLEASE KEEP THIS MANUAL FOR FUTURE REFERENCE AS IT CONTAINS
IMPORTANT INFORMATION.

**FOR ANY PRODUCT ENQUIRIES OR ISSUES PLEASE CONTACT HUNTER PRODUCTS
AT WWW.ELECTRICRIDEON.COM.AU OR TOLL FREE HELP LINE 1800 224 094.**

DIRECTORY

(A) BEFORE USE - - - - -	P1
(B) SPECIFICATION - - - - -	P1
(C) PRECAUTIONS - - - - -	P2
(D) EXPLODED DIAGRAM - - - - -	P3
(E) PARTS - - - - -	P4
(F) ASSEMBLY DIAGRAM - - - - -	P5-P6
(G) FUSE - - - - -	P7
(H) CHARGING AND BATTERY SAFETY - - - - -	P7
(I) CARE AND MAINTENANCE - - - - -	P8
(J) TROUBLESHOOTING GUIDE - - - - -	P8
(K) OPERATION AND FUNCTION - - - - -	P9

(A) BEFORE USE

Please read the product manual carefully before use. Please follow the detailed installation guide and follow the correct procedures to avoid potential damage or injury which may be caused due to improper use. It is particularly important that you read and follow the safety instructions and precautions. Please keep this manual in a safe place for future reference.

(B) SPECIFICATION

External dimensions	62*38*45cm	Power Mode	Rechargeable
Age Grade	suitable for children between 18M-36M	Charging Spec	DC8V 500MA
Loading limitation	20 KG	Charging Time	8-12 hours
Speed	3 km/hr	Power life	280 times charging
Battery Spec	6V, 4.5AH	Fuse Spec	Self-resetting fuse

FOR ANY PRODUCT ENQUIRIES OR ISSUES PLEASE CONTACT HUNTER PRODUCTS AT WWW.ELECTRICRIDEON.COM.AU OR TOLL FREE HELP LINE 1800 224 094.

(C) PRECAUTIONS



WARNING:

ADULT ASSEMBLY REQUIRED.

Read all instructions carefully before assembling this product.



WARNING: ASSEMBLY

- Keep these instructions for future reference.
- Prior to assembly, this package contains small parts: hardware which is a choking hazard and may contain sharp edges and sharp points. Keep product away from children until assembled.
- Ensure working area is free of danger, always dispose packaging material in such a way that it may not cause any harm. Plastic bags can be dangerous. To avoid suffocation, after suffocation keep plastic bags away from babies and children.
- To prevent serious injury, children must not use the equipment until completely assembled.
- Changing of spare parts should only be done by an adult. The battery is very heavy and the internal contents has acidic electrolytes. If battery leaking occurs, avoid contact with eyes. If there is accidental direct contact with battery leakage, it is imperative that the skin area is rinsed under cold water for at least 15 minutes. Please seek immediate medical attention.

IMPORTANT - MUST READ CAREFULLY



WARNING: USE

TO AVOID SERIOUS INJURY: Continuous adult supervision is required while this vehicle is in operation.

- To reduce the risk of injury, adult supervision is required. DO NOT leave the child play vehicle alone to avoid accidents.
- NEVER use in or near roadways, near motor vehicles, on or near steep inclines or steps, swimming pools or other bodies of water and dangerous place, always wear shoes, and NEVER allow more than 1 rider.
- NEVER allow children to ride at night.
- Instruct children on proper use of this product and to sit properly when driving. DO NOT RIDE VEHICLE STANDING UP.
- It is recommended that the rider always wears safety equipment such as fitted helmet when riding the vehicle.
- Ride-on toys should be used with caution since skill is required to avoid falls or collisions which may cause injury to the user.
- The vehicle is intended for use on flat, level surfaces.
- DO NOT ride the vehicle indoors. It is intended for outside use ONLY. Interior floors can be damaged by riding the vehicle indoors.
- DO NOT tow objects behind the vehicle or overload the vehicle as doing so will cause damage.

FOR ANY PRODUCT ENQUIRIES OR ISSUES PLEASE CONTACT HUNTER PRODUCTS AT WWW.ELECTRICRIDEON.COM.AU OR TOLL FREE HELP LINE 1800 224 094.

(D) EXPLODED DIAGRAM

NOTE: Some Parts Shown are assembled on both sides of vehicle

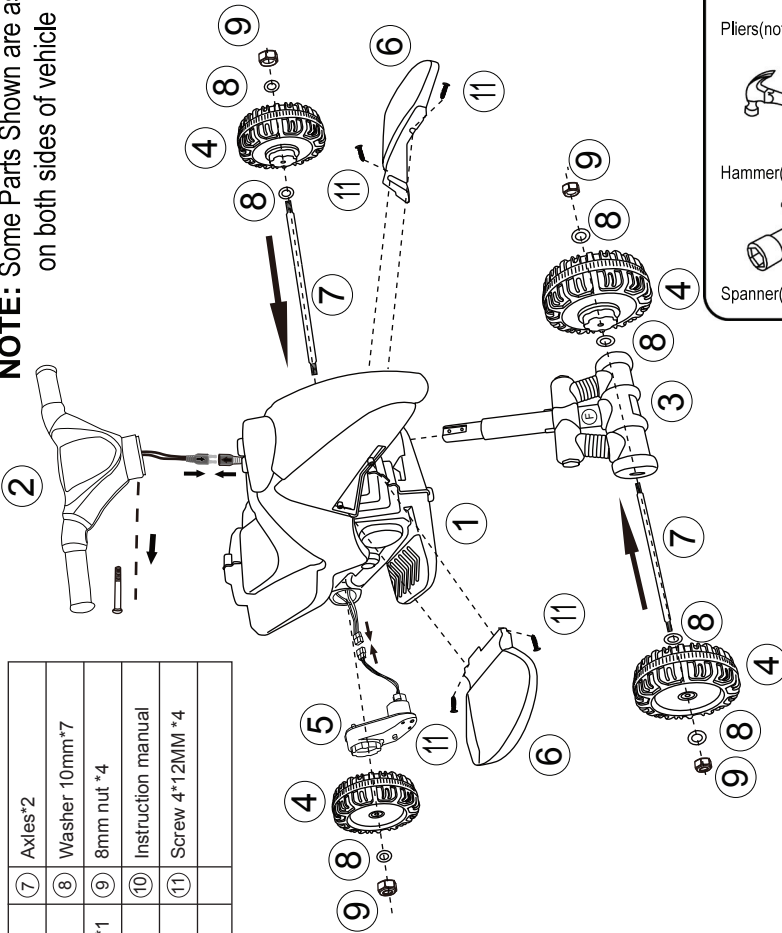

①	Vehicle body*1	⑦	Axles*2
②	Handle bar*1	⑧	Washer 10mm*7
③	Front wheel bracket*1	⑨	8mm nut *4
④	Wheel*4	⑩	Instruction manual
⑤	Gear box *1	⑪	Screw 4*12MM *4
⑥	Mud guard*2		

Tools Required



Screwdriver(not included)



Pliers(not included)

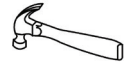



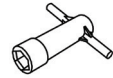





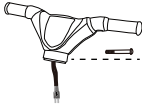
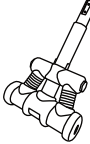

Hammer(not included)



Spanner(included)

FOR ANY PRODUCT ENQUIRIES OR ISSUES PLEASE CONTACT HUNTER PRODUCTS AT WWW.ELECTRICRIDEON.COM.AU OR TOLL FREE HELP LINE 1800 224 094.

(E) PARTS

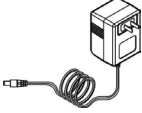
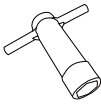
PART NO	PART NAME	PICTURE	Qty (pcs)	REMARKS	PART NO	PART NAME	PICTURE	Qty (pcs)	REMARKS
1	Vehicle body		1		2	Handle bar		1	with a 5*30mm screw
3	Front wheel bracket		1		4	wheel		4	
5	Gear box		1		6	Mud guard	 Left mud guard  Right mud guard	1	
7	Axles		2		8	Washer 10mm		9	2 pcs for spares
9	8mm nut		4		10	Instruction manual		1	
11	screw 4*12MM		4		12	Charger		1	
13	Spanner (included)		2						

OR ANY PRODUCT ENQUIRIES OR ISSUES PLEASE CONTACT HUNTER PRODUCTS AT WWW.ELECTRICRIDEON.COM.AU OR TOLL FREE HELP LINE 1800 224 094.

(F) ASSEMBLY DIAGRAM

1. Wheels assembly

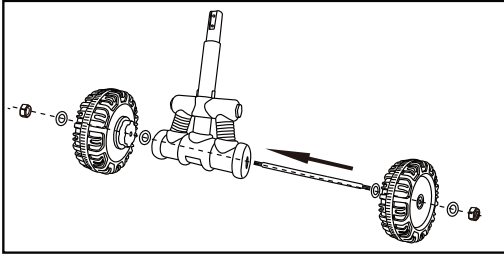

Assemble the front wheels as shown in this diagram.

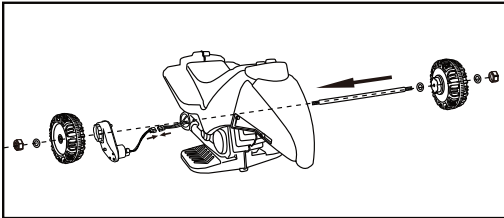

Insert the rear axle, slide the motor onto the axle & assemble the rear wheels as shown in this diagram. Ensure motor is plugged to the bike inside the battery compartment after assembly.

2. Mud guard assembly

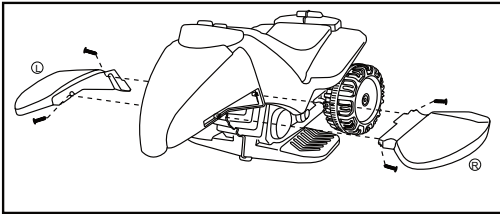

Insert mud guards into the main body of the bike as per this diagram. Fix in place using 4 x 12 screws (part # 11)

3. Handle bar assembly

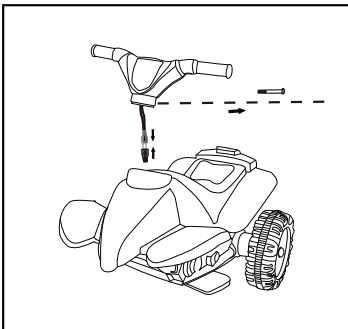

Remove the bolt from the handlebar to remove handlebar from bike. Join the 2 plugs together as per diagram above.

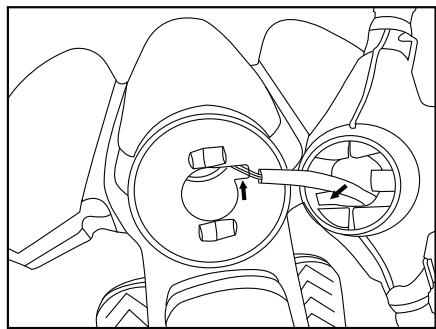

Once plugs are connected, insert the cabling into the handlebar hole as per the diagram above.

FOR ANY PRODUCT ENQUIRIES OR ISSUES PLEASE CONTACT HUNTER PRODUCTS AT WWW.ELECTRICRIDEON.COM.AU OR TOLL FREE HELP LINE 1800 224 094.

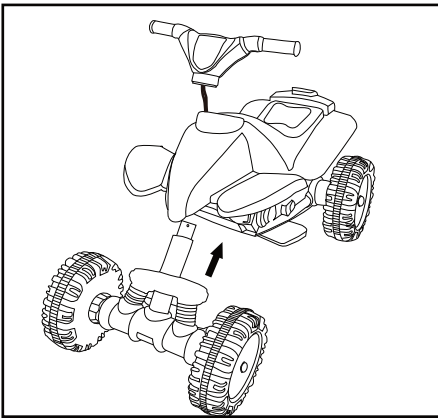

Insert front wheel assembly into the front of the bike as per the diagram above.

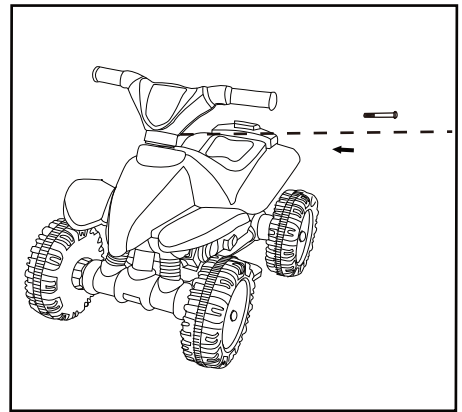

Insert the handlebar closely combined with the front wheel assembly, fix in place with a 5 x 30 screw.

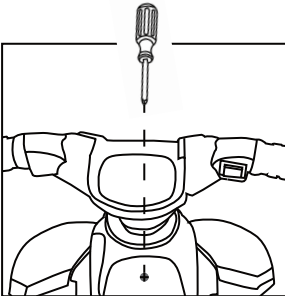

(1)

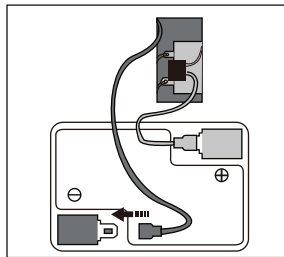

(2)

Open the seat by loosening screw on the seat.

Ensure red cable is connected to the red terminal of battery.

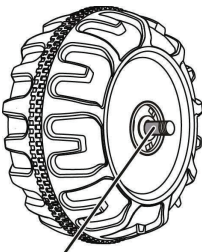

GAP

IMPORTANT SUPPLEMENT TO INSTRUCTION MANUAL

After assembling the wheels to the axles, please check the gap between the inside of the wheel and the vehicle (refer to the picture) If the gap is too big, please add 2 or 3 washers on the inside of the wheel. After tightening the nut outside of the wheel, please turn the wheel to check if it is running smoothly, if it is not smooth remove 1 or 2 washers and test it again.

OR ANY PRODUCT ENQUIRIES OR ISSUES PLEASE CONTACT HUNTER PRODUCTS AT WWW.ELECTRICRIDEON.COM.AU OR TOLL FREE HELP LINE 1800 224 094.

(G) FUSE

The vehicle uses a self-tapping fuse.

If the vehicle is overloaded or used incorrectly, the fuse will automatically 'trip' and shut down operation of the vehicle. Wait approximately 10-20 seconds before operating the vehicle again.

To avoid the vehicle shutting down, please pay attention to:

- (1) The maximum weight limit of the vehicle is 20KG.
- (2) Do not tow anything behind the vehicle.
- (3) Do not immerse in water or liquid, it may cause a short-circuit.
- (4) Do not revise the vehicle's circuit or the structure.
- (5) Do not use a different specification fuse.

(H) CHARGING AND BATTERY SAFETY

As shown in below diagram, insert the charger into the vehicle's charging hole, and the power plug into the matched stable AC power

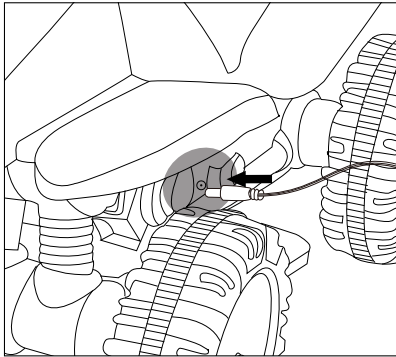

WARNING:
DO NOT allow children to play with the battery and charger. IT IS NOT A TOY.

NOTE:

- (1) Battery charging and replacement should only be done by an adult.
- (2) Insert battery with the correct polarity (+ and -).
- (3) For first time use, ensure that the battery has been charged at least 10 hours. Normal recharge should be 8-10 hours after every use.
NEVER charge for over 15 hours at a time.
- (4) CHECK the charger, battery and plug for any defects before charging every time.
DO NOT use if it is broken.
DO NOT use upside down or when the battery is charging.
- (5) DO NOT open the battery or charger. ONLY USE the type of battery and charger that is specified and recommended for the unit
- (6) DO NOT short-circuit battery.
- (7) DO NOT recharge non-rechargeable battery.
- (8) DO NOT mix old and new or different types of batteries.
- (9) DO NOT dispose of battery in fire as it may leak or explode.
- (10) Exhausted battery is to be removed from the toy.
- (11) When vehicle is not used for an extended time, remove battery to prevent possible leakage and damage to the unit.
Charge the battery once every three months to extend the lifetime of the battery.

FOR ANY PRODUCT ENQUIRIES OR ISSUES PLEASE CONTACT HUNTER PRODUCTS AT WWW.ELECTRICRIDEON.COM.AU OR TOLL FREE HELP LINE 1800 224 094.

(I) CARE AND MAINTENANCE

- (1) An adult should regularly check things such as plugs, electrical, housing and steering systems. If fastenings are in normal working order, It is suggested these checks are done every two weeks. If there are any problems, STOP use immediately until the issues are resolved and the unit is back in working order.
- (2) Clean vehicle with soft and dry cloth, do not use water directly or chemicals as this may lead to corrosions and cause switch failure.
- (3) DO NOT wash with soapy water or spray vehicle with a hose.
- (4) DO NOT wipe vehicle with car wax or other wax-based polish.
- (5) DO NOT drive vehicle during wet or snowy weather as moisture can cause corrosion in the motor or electrical switches.
- (6) DO NOT drive vehicle on gravel or sand as doing so may cause motor to jam.
- (7) Store vehicle indoors or cover with a protective tarp during inclement weather.
- (8) DO NOT store the vehicle in high-temperature places, near fire, or in moist places.
- (9) When vehicle is not used on a regular basis, please pull out the battery, the switch must be in the "off" position to ensure circuit safety. Charge the battery once every three months to extend the lifetime of the battery.
- (10) DO NOT make modifications to this vehicle.
When maintaining, do not revise the vehicle's circuit and structure.
- (11) ONLY use the battery charger which comes with this vehicle. Not doing so may cause irreparable damage, including fire or explosion which may result in injury to the user.
- (12) In the unstable supply voltage region, we recommended to install voltage stabilizer to protect the battery.

(J) TROUBLESHOOTING GUIDE

Problem	Possible Solutions
The vehicle does not move	<ul style="list-style-type: none"> · Charge the battery. (Charge battery after each use.) NOTE: vehicle will be cut off electrically during charging. · Check all electrical connections. · Check that all switches are in the "on" position · Check that the foot switch or manual button is not stuck · The fuse may have been activated due to excessive weight or rough driving conditions. Wait at least 10~20 seconds, and the vehicle will reset itself. · Check is whether there is debris stuck wheels.
The vehicle begins to run slow	<ul style="list-style-type: none"> · Charge the battery. (Charge battery after each use.) · Only allow one rider at a time. · DO NOT exceed child weight limit: 20kg · Drive on level ground. · Battery may be old or not accepting a full charge. The battery will last from 1 to 3 years depending on care, use and environment. Replace with 6Volt 4.5 Ah battery only. · Check is whether there is debris stuck wheels.
The vehicle runs erratically	<ul style="list-style-type: none"> · There may be a problem with the fuse, or you may have a damaged battery.
The charger feels warm when in use	<ul style="list-style-type: none"> · This is normal.
The gears sound very loud and/or are making a grinding noise.	<ul style="list-style-type: none"> · The gears may be broken.

FOR ANY PRODUCT ENQUIRIES OR ISSUES PLEASE CONTACT HUNTER PRODUCTS AT WWW.ELECTRICRIDEON.COM.AU OR TOLL FREE HELP LINE 1800 224 094.

(K) OPERATION AND FUNCTION

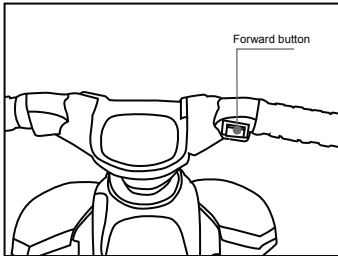

(3)

Operating Instruction:

Note: Begin by teaching your child how to steer & control the handlebars.

Press and hold the button on the handlebar. The vehicle drives forward.

Release the button to stop.

Our goods come with guarantees that cannot be excluded under the Australian Consumer Law. You are entitled to a replacement or refund for a major failure and for compensation for any other reasonably foreseeable loss or damage. You are also entitled to have the goods repaired or replaced if the goods fail to be of acceptable quality and the failure does not amount to a major failure.

For New Zealand customers, this warranty is in addition to statutory rights observed under New Zealand legislation.

Where a failure does not amount to a major failure, we are entitled to choose between providing you with a repair, replacement or refund. To obtain compensation, you would need to provide documentary evidence of the loss or damage suffered, and documentary evidence that such loss or damage was a reasonably foreseeable consequence of a failure by us to comply with a consumer guarantee under the Australian Consumer Law. Such evidence may include photographs, statutory declarations, receipts or reports (e.g. from your doctor), depending on the loss or damage.

In addition to all rights and remedies to which you may be entitled under the Competition and Consumer Act 2010 (Commonwealth) and any other relevant legislation, the manufacturer warrants this product to be free from defects in materials or workmanship for a period as stated on the packaging from the date of purchase.

In order to claim under this warranty, you will need to bring the product to the store of purchase, along with proof of purchase (typically this will be a receipt). Any cost incurred by you in bringing the product to the service desk will be borne by you. We will then, at our option, either repair or replace the product, or refund your money and take back the product.

Our liability under this manufacturer's warranty is subject to us being satisfied that a defect was caused by defective workmanship or materials, and was not caused by or substantially contributed to by other factors, or circumstances beyond our control, including (but not limited to) defective installation, maintenance or repair, alteration or modification of the product in any manner not recommended by the manufacturer or any neglect, misuse or excessive use.

The benefits conferred by this manufacturer's warranty are in addition to all rights and remedies conveyed by the Competition and Consumer Act 2010 (Commonwealth), and any other statutory rights to which you may already be entitled, and this warranty does not exclude, restrict or modify any such rights or remedies that are implied by law.

HUNTER PRODUCTS

Level 2, 424 Warrigal Road Moorabbin 3189

Ph: 1800 224 094

Email: enquiries@hunterproducts.com.au

070517

**FOR ANY PRODUCT ENQUIRIES OR ISSUES PLEASE CONTACT HUNTER PRODUCTS
AT WWW.ELECTRICRIDEON.COM.AU OR TOLL FREE HELP LINE 1800 224 094.**